

**Redundant LNA systems minimize system downtime due to LNA failure by providing a spare LNA and an automatic means of switching to the spare upon failure of a primary LNA.**

A 1:1 system provides one spare LNA for one primary LNA. A 1:2 system provides a spare LNA for either of two primary LNAs. The systems consist of an outdoor plate assembly which mounts at the antenna hub, an indoor control panel and interconnecting control cable.

### System Block Diagram

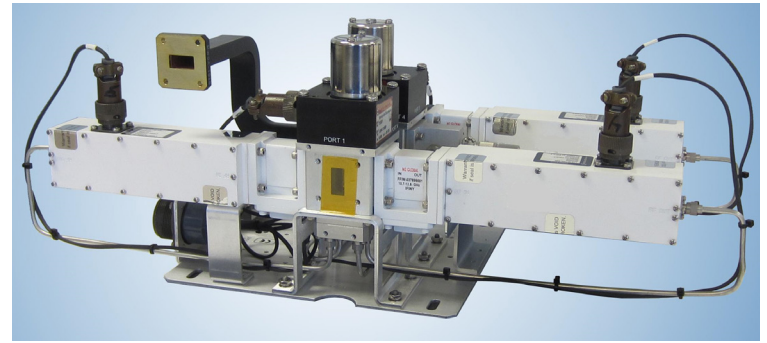
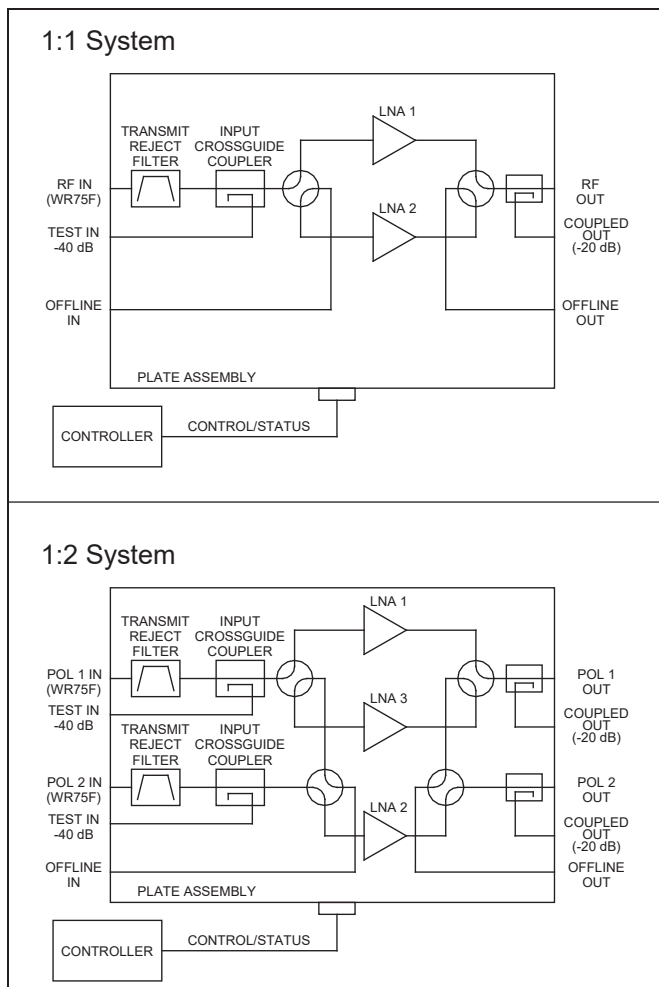

*Typical Ku-Band 1:2 LNA Plate Assembly*

### PLATE ASSEMBLY FEATURES:

- LK-12000 Series Ku-Band Low Noise Amplifiers (LNAs)
- High quality dual waveguide/coaxial switches
- Manual override
- Waveguide input flanges
- Output coaxial isolators standard
- Transmit reject filter(s), input crossguide coupler(s), output coax coupler(s) and offline I/O options available

### REDUNDANCY CONTROLLER FEATURES:

- 10/100 Base T Ethernet network interface
- Supports SNMP v1, v2c, and v3
- Rack-mount chassis, 19" wide, 1 3/4" (1 RU) high
- Dual, redundant power supplies
- Manual or automatic operation
- Monitors unit currents, external alarms, or both
- Automatically switches RF path to standby unit when unit failure occurs
- User-selectable RS-232/-422/-485 serial I/O M&C interface
- Parallel I/O M&C interface
- Menu-driven user configuration of all options
- Front panel graphically depicts switch positions and unit status
- Worldwide universal AC input capability standard
- Audible alarm
- CE certified and RoHS compliant; EAR 99
- Monitor and Power Tracking Unit in monopulse systems

**System Specifications (1)**

Parameter	Notes	Specification
<b>Frequency Range</b>	Band "E" Band "R"	10.95 to 12.75 GHz 10.70 to 12.75 GHz
<b>Noise Temperature, System</b>	At +23°C Versus Temperature	See Table 1 See Table 2
<b>Gain</b>	Standard LNA LNA with Option 1	60 dB min., 63 dB typical 50 dB min., 53 dB typical
<b>Gain Match</b>		1 dB max. between LNAs
<b>Gain Flatness</b>		±0.75 dB over the full band ±0.30 dB per 40 MHz
<b>Gain Stability</b>		±0.2 dB max., per day, constant temperature -0.04 versus temperature
<b>VSWR</b>	Input, standard Input, with System Option B, Tx filter Output	1.20:1 typical, 1.25:1 max.  1.25:1 typical, 1.30:1 max. 1.20:1 typical, 1.25:1 max.
<b>Power Output at 1dB compression (P<sub>1dB</sub>)</b>	Standard LNA LNA with Option 2 LNA with Option 2 and System Option D, output couplers	+10 dBm min., +13 dBm typical +18 dBm min., +20 dBm typical  +17 dBm min., +19 dBm typical
<b>3<sup>rd</sup> Order Output Intercept Point (OIP<sub>3</sub>)</b>	Standard LNA LNA with Option 2 LNA with Option 2 and System Option D, output couplers	+20 dBm min., +23 dBm typical +28 dBm min., +30 dBm typical  +27 dBm min., +29 dBm typical
<b>AM/PM Conversion</b>		0.05°/dB max., at -5 dBm out
<b>Group Delay per 40 MHz</b>	Linear Parabolic Ripple	0.02 ns/MHz 0.002 ns/MHz <sup>2</sup> 0.2 ns peak to peak
<b>Maximum Input Power</b>	Without damage	0 dBm max.
<b>Desensitization Threshold for 13.75 – 14.50 GHz In</b>	Standard system With System Option B, Tx filter	-20 dBm  +30 dBm
<b>Connectors</b>	RF Input RF Output Offline In/Out, Coupler In/Out	WR75F Waveguide Flange Type N Female (2) Type N Female (2)
<b>Plate Assembly Power Requirements (for use with standard product LNAs)</b>	LNA Voltage LNA power, 1:1 System LNA power, 1:2 System Switch voltage Switch power	11 VDC min., 15 VDC typical, 24 VDC max. 6 W typical 10 W typical 28 VDC typical 2 A max.
<b>Temperature Range</b>	Switch Plate Assembly	-40°C to +60°C

(1) System specifications depend on choice of LNA and various options. Specifications shown are for a typical system using LK-12000 series LNAs (Specification 5908).

(2) SMA Female connectors available on request (custom option).



## Redundant System Controller



1:2 Redundant System Controller, Model RSC12V1-AC

The RSC series redundant system controllers for 1:1 and 1:2 systems directly power the LNAs and monitor the output voltages and currents to detect faults. The RSC can also monitor external alarm signals or a combination of output currents and external alarm inputs. Upon detecting a fault, the RSC transfer switch to activate the spare unit.

The RSC offers monitoring and control of auxiliary RF hardware; remote monitor and control via network, serial interface, or parallel I/O; flexible configuration of system behaviour; remote disable of local controls for security; and the ability to detect and report certain failures within the controller itself.

A second RSC can be linked to a primary RSC to provide full system control from an alternate control site. When set up this way, the secondary RSC is referred to as a remote control panel, or RCP. The configuration and settings of the primary RSC are transferred to the RCP, which then mimics its controls and interfaces. This permits system operation from a location that is up to 4000 ft. (1200 m) distant from the primary controller.

## Controller Specifications

Unit Status Monitor Methods	Controller monitors unit bias current; alarm is generated if current goes outside of allowed tolerance window (LNA or LNB systems). Controller also monitors external alarm inputs (SSPA and other systems) or combinations of both internal unit current and external alarm inputs.
Unit Current Window Width	±5% to ±25% of nominal; user selectable in 5% steps (applies to all monitored unit currents)
Switchover Time	100 ms maximum
Unit Power Outputs	+14.3 to +15.0 Vdc, 700 mA maximum
Switch Drive Outputs	-22 to -28 Vdc, 2 A maximum
External Alarm Inputs	Optionally up to one per unit; require sinking 5 mA at 5 Vdc to negate alarm
Serial I/O Interface	RS-232/RS-422/RS-485 2- or 4-wire; user selection
Parallel I/O Interface	Control inputs: Contact closures to ground; require sinking 20 mA at 15 Vdc Status outputs: Form 'C' dry contacts; 100 Vdc, 0.5 A, 3 W max (resistive load)
Controller Dimensions	19" (483 mm) W x 1.72" (43.7 mm) H x 17.5" (445 mm) D; 7.6 lb (3.4 kg)
Chassis Slides	Standard. Radio relay rack-mount brackets available on request.
Cable Length to Plate Assy	<b>Order cable separately.</b> 100 ft (30 m) to 250 ft (75 m) lengths in 50 ft (15 m) increments are standard; other lengths (up to 500 ft or 150 m) are available by special order.
AC Input (standard)	100-135 or 180-240 Vac, 47-63 Hz, 100 W; Dual AC inputs and dual redundant power supplies.
Temperature Range	Operating: 0 to +50 °C (indoor equipment environment) Storage: -40 to +70 °C
Reliability	MTBF: 48,200 hours; MTTR: less than 30 minutes with spares and proper technical person.

### Controller Front Panel Controls and Indicators

Unit Status Alarms	LED Indicators glow green when OK, red when a fault is detected.
PS Indicator	Glow red to show fault with either dual redundant power supply.
Panel Test	Pushbutton lights all indicators & tests audible alarm.
RF Switch Pushbuttons and Indicators	<p>Pushbuttons are used to manually switch units. Front panel indicators show which units are on-line. Unit indicators light red to show faulted units.</p> <p>In a typical 1:1 system, Unit 1 is the primary unit and Unit 2 is on standby. In a 1:2 system, Unit 1 is the primary unit for Pol 1 and Unit 2 is the primary unit for Pol 2. Unit 3 is on standby and can be selected for either Pol. In a dual 1:1 system, Unit 1 is the primary unit and Unit 2 is on standby for Pol 1; Unit 3 is the primary and Unit 4 is on standby for Pol 2.</p>
Auto/Manual Switch and Indicators	In Auto mode, a unit failure initiates automatic switchover to the standby unit. In manual mode, the on-line unit can be selected from the front panel or by serial I/O, parallel I/O or network command.
Remote/Local Switch and Indicators	<p>Selects local (front panel) control, or remote control from serial I/O, parallel I/O, or network.</p> <p>An optional second RSC, configured as a Remote Control Panel, provides the means to operate the system from a physically distant, alternate location.</p>

### Controller Rear Panel Interfaces

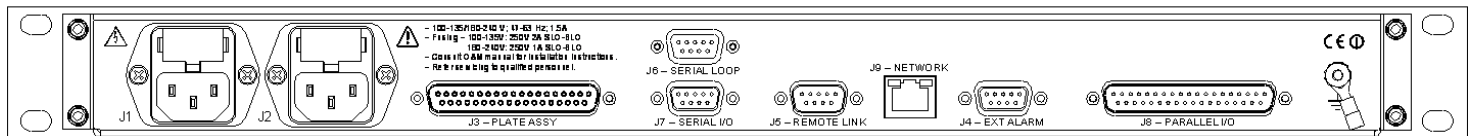

J1, J2 – LINE 1, LINE 2 (IEC 320-C14)	Dual power entry modules contain the AC line input connectors. System can be powered from separate AC lines if desired. Either or both power supplies are capable of operating the system.
J3 – PLATE ASSY (37-pos D, Female)	Cable to plate assembly carries unit power (for line drivers, LNAs or LNBs) and switch drive signals. <b>Order cable separately.</b> Standard lengths are 100' (30 m) to 250' (75 m) in 50' (15 m) increments; other lengths are special order. An adapter cable mates the controller to legacy system cables.
J6 – SERIAL I/O and J7 – SERIAL LOOP (9-pos D Female)	RS-232/RS-422/RS-485 connector for user M&C System. Commands provide monitoring, controlling, and configuration. Interconnect cable lengths to 4000 ft (1200 m) with RS-422 or RS-485. A serial loop connector provides a convenient connection for daisy-chained systems.
J5 – REMOTE LINK (9-pos D Male)	For connection via a proprietary RS-422 link (up to 4000 ft/1200 m) to an optional, second RSC, which duplicates Local control functions at a secondary site.
J9 – NETWORK (RJ-45)	10/100 Base T Ethernet connection port via standard RJ-45 connector. Supports SNMP v1, v2c and v3.
J4 – EXT ALARM (9-pos D Female)	External Alarm inputs. Substitute for or combine with internal unit current monitor alarms. Allows an external signal to indicate unit failure. Unused inputs can be used as status inputs to M&C system.
J8 – PARALLEL I/O (37-pos D Male)	<p>Parallel I/O (discrete logic) connection for limited control and monitoring of the system.</p> <p>Form 'C' relay contact outputs (1:2 system example):</p> <ul style="list-style-type: none"> <li>• Unit 1 status</li> <li>• Unit 2 status</li> <li>• Unit 3 status</li> <li>• PS 1 status</li> <li>• PS 2 status</li> <li>• Local/Remote mode</li> <li>• Pol 1: Unit 1 or Unit 3</li> <li>• Pol 2: Unit 2 or Unit 3</li> <li>• Auto/Manual mode</li> </ul> <p>Control inputs—contact closure to ground (1:2 system example):</p> <ul style="list-style-type: none"> <li>• Pol 1 Unit 1 select</li> <li>• Pol 1 Unit 3 select</li> <li>• Pol 2 Unit 2 select</li> <li>• Pol 2 Unit 3 select</li> <li>• Auto/Manual select</li> </ul>

1:1 Plate Assembly Outline Drawing, with Various Options Installed

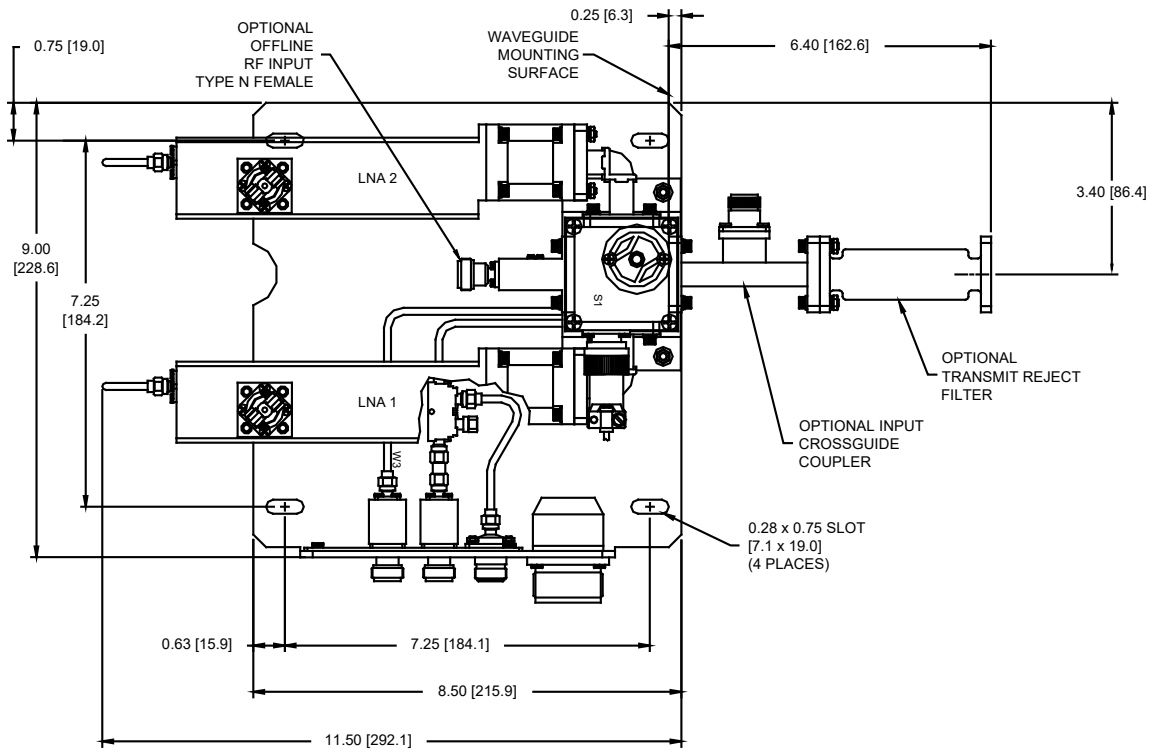

NOTES:

1. OUTPUT ISOLATOR INCLUDED WITH STANDARD SYSTEM.
2. OPTIONAL TRANSMIT REJECT FILTER, CROSSGUIDE COUPLER, OUTPUT COAXIAL COUPLER AND OFFLINE INPUT/OUTPUT SHOWN.
3. DIMENSIONS ARE IN INCHES [mm].

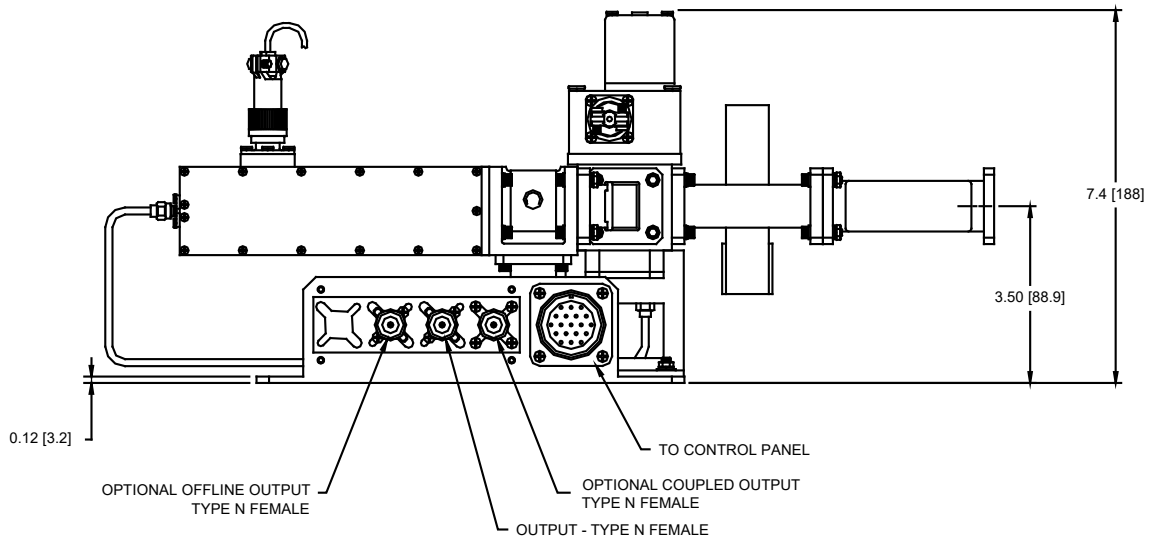

Outline 12670-2

1:2 Plate Assembly Outline Drawing, with Various Options Installed

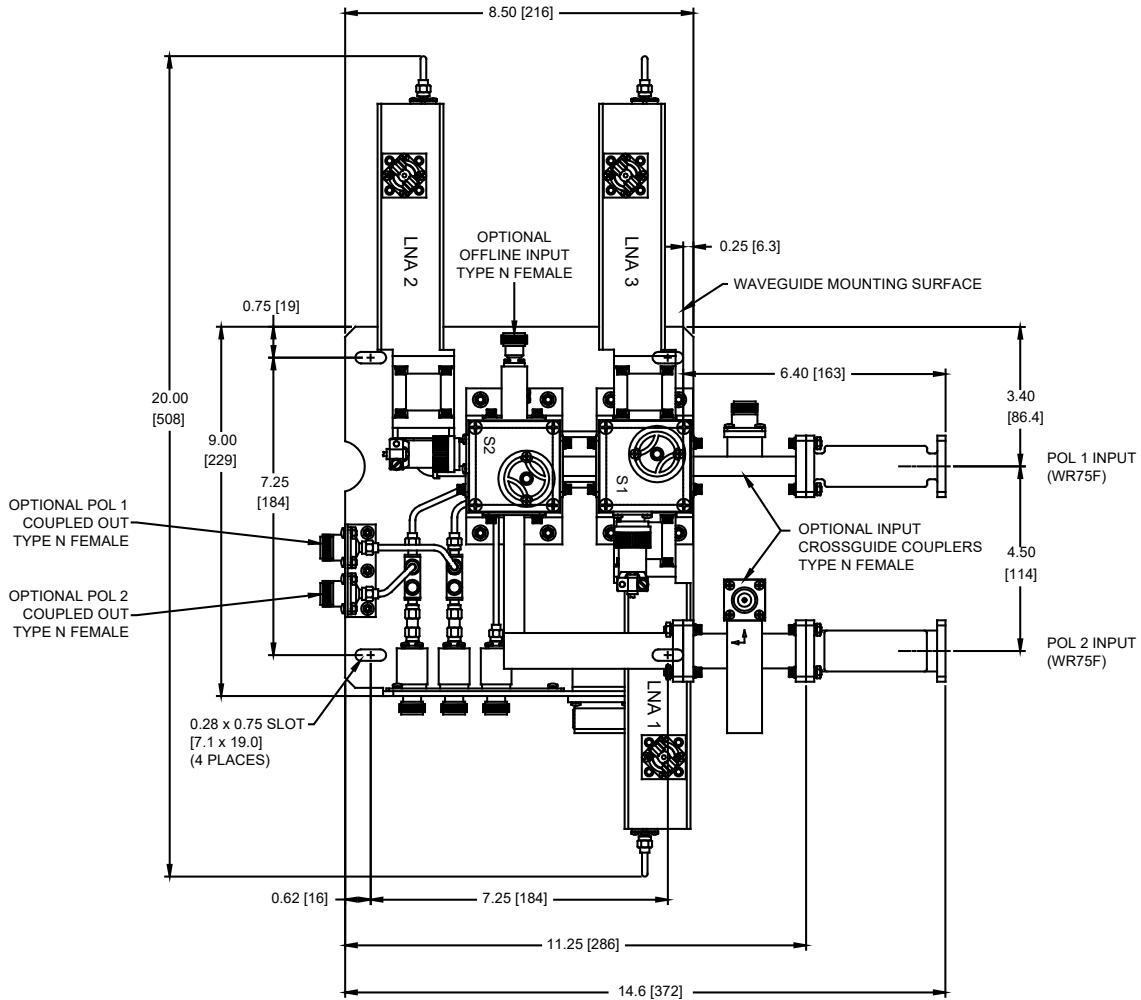

NOTES:

1. OUTPUT ISOLATORS INCLUDED WITH STANDARD SYSTEM
2. OPTIONAL INPUT CROSSGUIDE COUPLERS, TRANSMIT REJECT FILTERS, OFFLINE INPUT/OUTPUT AND OUTPUT COAX COUPLERS SHOWN
3. DIMENSIONS ARE IN INCHES AND [mm].

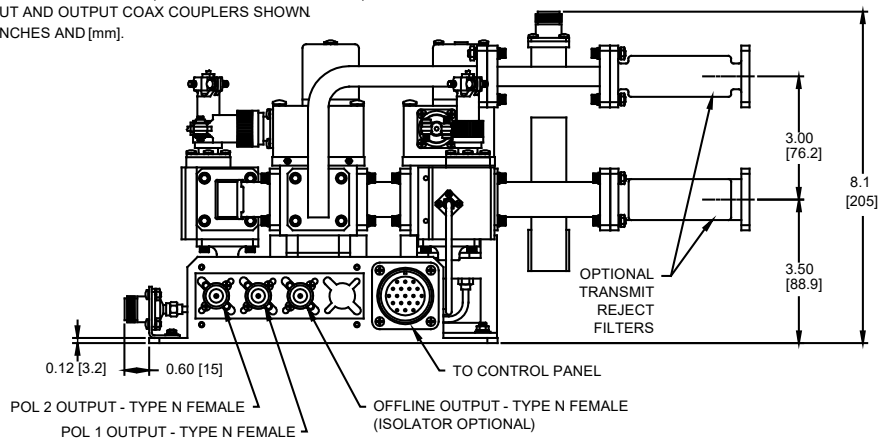

Outline 12671-3